

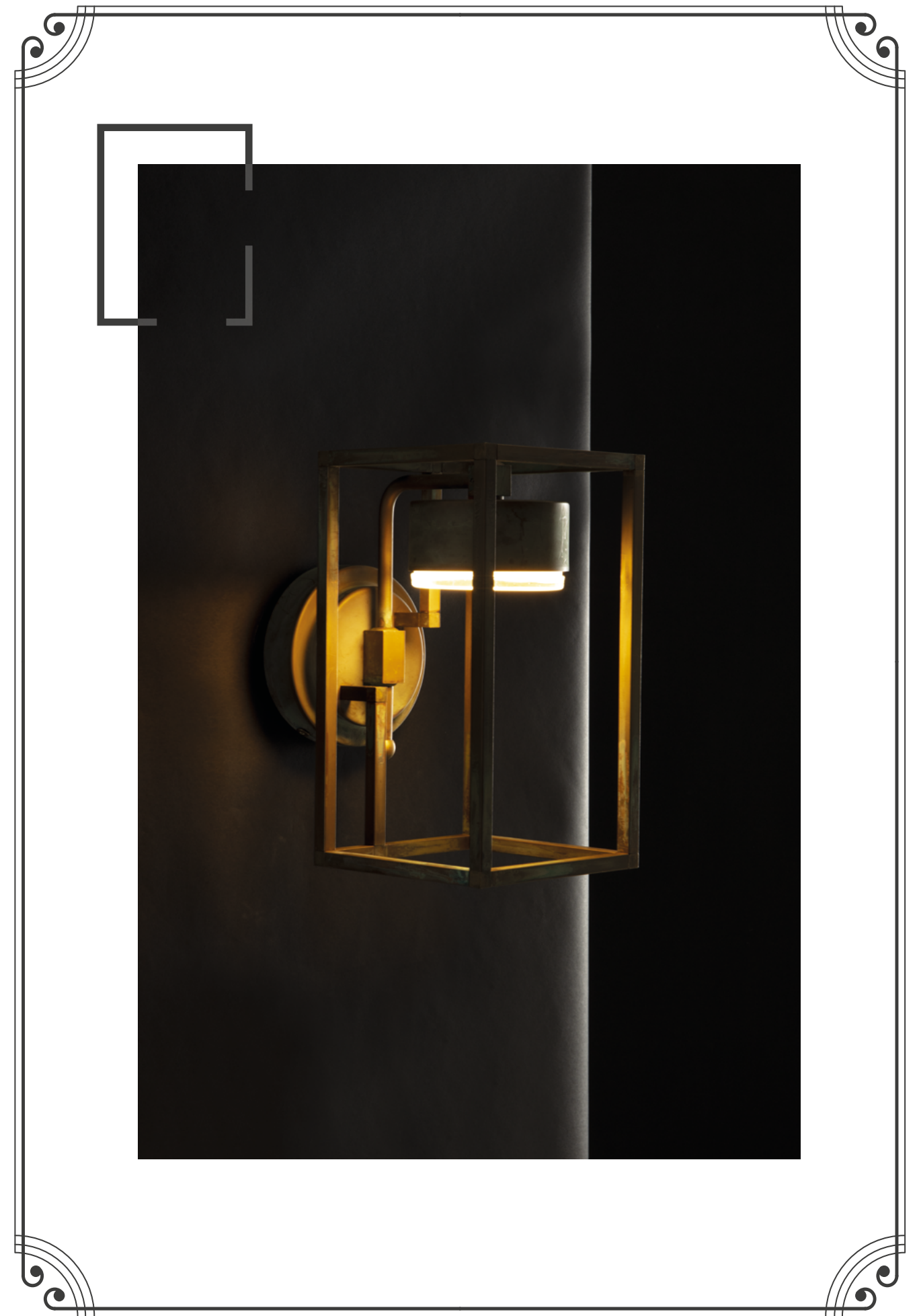

# Cubic<sup>3</sup>

for outdoor





3372.E27.T.AR

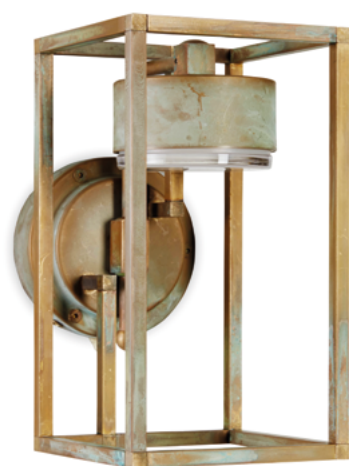

3372.L10.AR

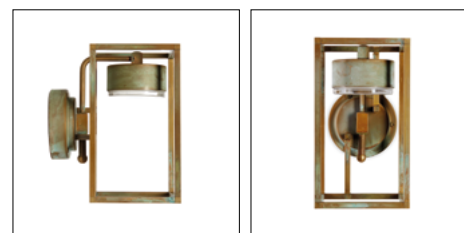



NEW Cubic | outdoor



3373.L10.AR



Page 173

**SPECIFICHE TECNICHE**

**TECHNICAL SPECIFICATIONS**



	<b>3372 E27</b>	<b>3372 LED</b>	<b>3373 LED</b>
Sorgente luminosa Source lamp	E27	LED 13 W	LED 13 W
Potenza assorbita Total Wattage	Max 15W	15W	15W
Voltaggio totale Voltage	220-240 V	220-240 V	220-240 V
Regolazione Control	Lampadina non inclusa Bulb not included included	Trasformatore incluso Power supply included	Trasformatore incluso Power supply included
Temperatura colore Light colour	-	3000 K	3000 K
Flusso nominale Luminous Flux	-	-	-
Efficienza luminosa Luminous efficacy	-	1600 lm	1600 lm
Step McADAM	-	3	3
Apertura cono luce Beam	Diffondente - Diffuse	Diffondente - Diffuse	Diffondente - Diffuse
Durata Life time	-	L80 > 80.000 h Ta -40°C +55°C	L80 > 80.000 h Ta -40°C +55°C
Classe efficienza energetica Energy efficiency class	-	D	D
Grado IP IP rating	IP 44	IP 65	IP 65
Grado IK IK rating	-	IK07	IK07
Classe isolamento Insulation class	I	I	I

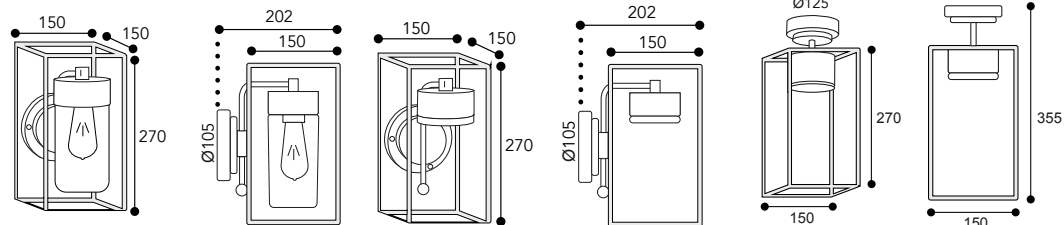

Dimensioni  
Dimensions

Codice  
Code

3372.E27. T  
O AR  
NA  
1  
5      3372.L10. AR  
NA  
1  
5      3373.L10. AR  
NA  
1  
5

Dimensioni lampadina  
Bulb dimensions

Ø67 H110 (mm)

**SPECIFICHE TECNICHE**

**TECHNICAL SPECIFICATIONS**



	<b>3367 E27</b>
Sorgente luminosa Source lamp	E27
Potenza assorbita Total Wattage	Max 52 W
Voltaggio totale Voltage	220-240 V
Regolazione Control	Lampadina non inclusa Bulb not included included
Temperatura colore Light colour	-
Flusso nominale Luminous Flux	-
Efficienza luminosa Luminous efficacy	-
Step McADAM	-
Apertura cono luce Beam	-
Durata Life time	-
Classe efficienza energetica Energy efficiency class	-
Grado IP IP rating	IP 44
Grado IK IK rating	-
Classe isolamento Insulation class	I

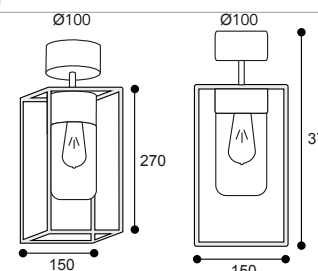

Dimensioni  
Dimensions

Codice  
Code

3367.E27. T  
O AR  
NA  
1  
5

Dimensioni lampadina  
Bulb dimensions

Ø67 H110 (mm)

**Legenda - Caption**

cod **Finiture - Finishing**

**AR** Ottone anticato  
Aged brass

**NA** Ottone nickelato  
Nickelated brass

**1** Nero  
Black

**5** Bianco  
White

cod **Vetro - Glass**

**T** Trasparente  
Transparent

**O** Opale  
Opal

**Informazioni - Information**

Lampadina non inclusa  
Bulb not included

AR non teme la salsedine  
AR no problem salt corrosion

Conforme alla direttiva UE  
Compliant with EU Directive

Conforme alla direttiva UK  
Compliant with UK Directive

**EUIPO  
Certificate of registration**

015021990-0001

015021990-0002

015021990-0003





3365.O.AR



3365.T.AR

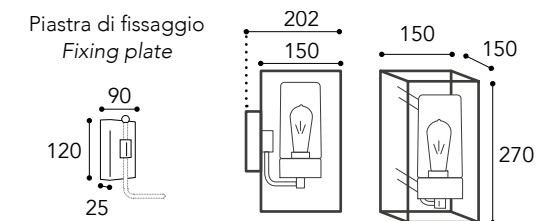

**Vetri/Glasses**

.T =  
Vetro trasparente  
Transparent glass

.O =  
Vetro opale  
Opal glass

**i** pag. 10 - 12



**CE**

IP44 - E27



.AR  
Non teme  
la salsedine  
No problem  
salt corrosion

Max Watt  
52



Lampadina  
non inclusa  
Bulb not included

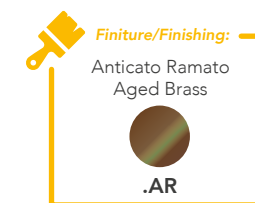

Finiture/Finishing:  
Anticato Ramato  
Aged Brass

.AR





3365.O.NA



3365.T.NA

**Vetri/Glasses**

**.T =**  
Vetro trasparente  
Transparent glass

**.O =**  
Vetro opale  
Opal glass

**i** pag. 10 - 12



**CE**  
IP44 - E27



**Max Watt**  
52

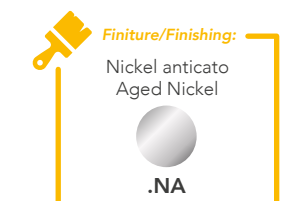



3365.O.1



3365.T.1







3365.O.6

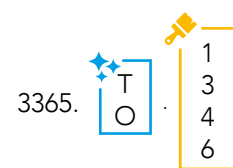

3365.T.6



**Finiture/Finishing:**

Nero Black	Nero/Argento Black/Silver	Nero/Verde Black/Green	Nero/Rame Black/Copper
			
.1	.3	.4	.6

**Vetri/Glasses**

- .T = Vetro trasparente / Transparent glass
- .O = Vetro opale / Opal glass

pag. 10 - 12



CE  
IP44 - E27



Max Watt  
52



**Finiture/Finishing:**

Nero/rame  
Black/copper



.6





3365.O.5



3365.T.5

**Vetri/Glasses**

**.T =**  
Vetro trasparente  
Transparent glass

**.O =**  
Vetro opale  
Opal glass

**i** pag. 10 - 12



**CE**  
IP44 - E27



Max Watt  
52

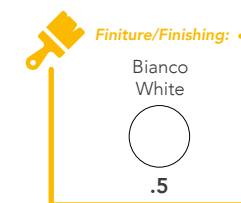





3366.O.AR



3366.T.AR

Piastra di fissaggio  
Fixing plate

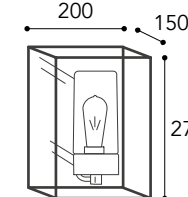
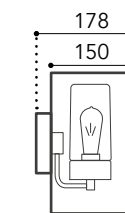
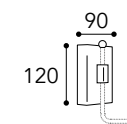

**Vetri/Glasses**

.T =  
Vetro trasparente  
Transparent glass

.O =  
Vetro opale  
Opal glass

**i** pag. 10 - 12



**CE**  
IP44 - E27



Max Watt  
52

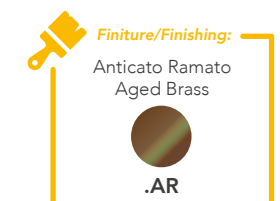



3366.O.NA



3366.T.NA



3366.O.1



3366.T.1



**Vetri/Glasses**

**.T =**  
Vetro trasparente  
Transparent glass

**.O =**  
Vetro opale  
Opal glass

**Finiture/Finishing:**  
Nickel anticato  
Aged Nickel

**.NA**

**i** pag. 10 - 12

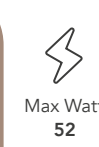

**Finiture/Finishing:**

Nero Black Black	Nero/Argento Black/Silver	Nero/Verde Black/Green	Nero/Rame Black/Copper
.1	.3	.4	.6



3366.O.6



3366.T.6



3366.O.5



3366.T.5

**Vetri/Glasses**

**.T =**  
Vetro trasparente  
Transparent glass

**.O =**  
Vetro opale  
Opal glass

**Finiture/Finishing:**  
Nero/rame  
Black/copper

**.6**

**i** pag. 10 - 12



**CE**  
IP44 - E27

**.AR**  
Non teme  
la salsedine  
No problem  
salt corrosion

Max Watt  
52

Lampadina  
non inclusa  
Bulb not included

**Finiture/Finishing:**  
Bianco  
White

**.5**





3364.O.NA

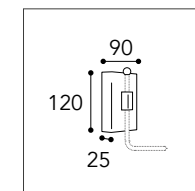

Piastra di fissaggio  
Fixing plate

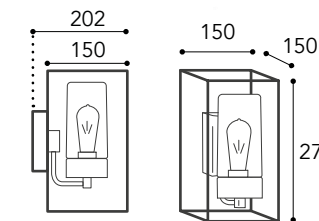

**Vetri/Glasses**



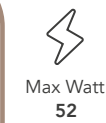

**.T =**  
Vetro trasparente  
Transparent glass

**.O =**  
Vetro opale  
Opal glass

**i** pag. 10 -12



**Finiture/Finishing:**

Anticato Ramato Aged Brass	Nickel anticato Aged Nickel	Nero Black	Bianco White
			
<b>.AR</b>	<b>.NA</b>	<b>.1</b>	<b>.5</b>





3363.T.AR



3363.O.AR

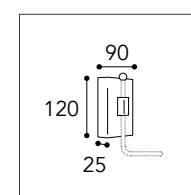

Piastra di fissaggio  
Fixing plate

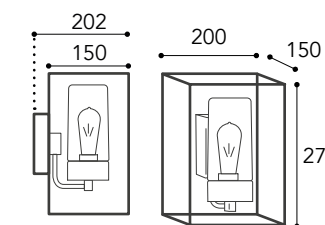

**Vetri/Glasses**

.T =  
Vetro trasparente  
Transparent glass

.O =  
Vetro opale  
Opal glass

**i** pag. 10 -12

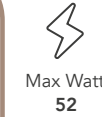

**Finiture/Finishing:**

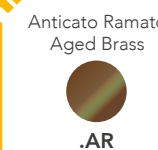



3363.T.NA



3363.O.NA



3363.T.1



3363.O.1

3363.  T  AR  
NA  
1  
5

3363.  T  1  
3  
4  
6

**Vetri/Glasses**  
**.T =**  
 Vetro trasparente  
 Transparent glass  
**.O =**  
 Vetro opale  
 Opal glass

 pag. 10 -12







**CE**  
IP44 - E27



  
Max Watt  
52



**Finiture/Finishing:**  
 Nero Black  .1  
 Nero/Argento Black/Silver  .3  
 Nero/Verde Black/Green  .4  
 Nero/Rame Black/Copper  .6



3362.O.NA

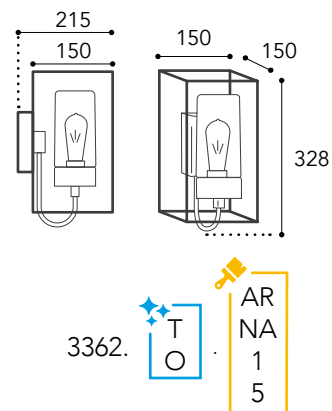

**Vetri/Glasses**

.T =  
Vetro trasparente  
Transparent glass

.O =  
Vetro opale  
Opal glass



3368.O.AR

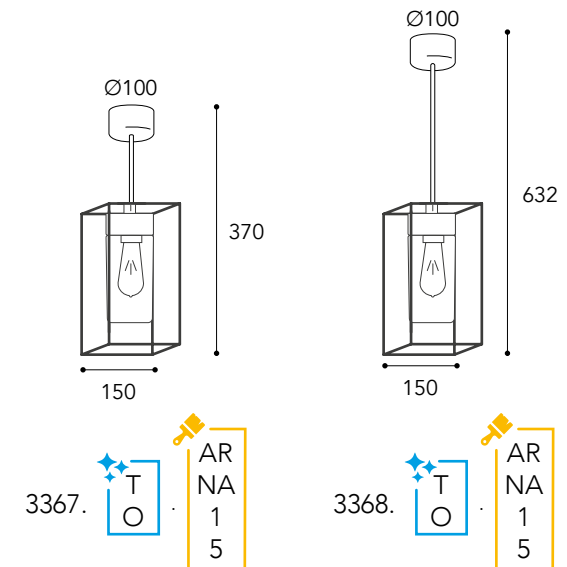

**Vetri/Glasses**

.T =  
Vetro trasparente  
Transparent glass

.O =  
Vetro opale  
Opal glass

i pag. 10 -12







CE  
IP44 - E27



Max Watt  
52



**Finiture/Finishing:**

Anticato Ramato Aged Brass	Nickel anticato Aged Nickel	Nero Black	Bianco White
			
.AR	.NA	.1	.5





3370.O.AR

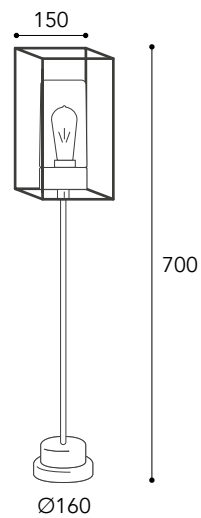

3370. T  
O AR  
NA  
1  
5  
...

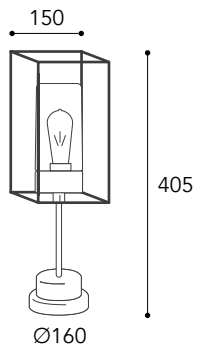

3369. T  
O AR  
NA  
1  
5  
...

**Finiture/Finishing:**

Nero/Argento Black/Silver	Nero/Verde Black/Green	Nero/Rame Black/Copper
.3	.4	.6

**Vetri/Glasses**

.T =  
Vetro trasparente  
Transparent glass

.O =  
Vetro opale  
Opal glass

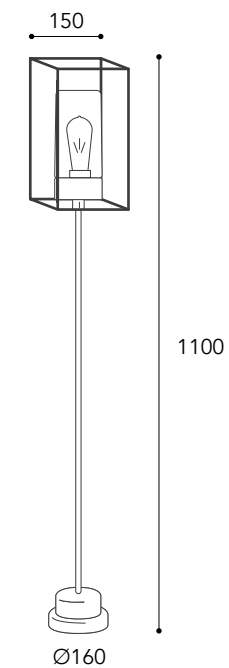

3371. T  
O AR  
NA  
1  
5  
...

**Vetri/Glasses**

.T =  
Vetro trasparente  
Transparent glass

.O =  
Vetro opale  
Opal glass

pag. 10 -12



CE  
IP44 - E27



Max Watt  
52



**Finiture/Finishing:**

Anticato Ramato Aged Brass	Nickel anticato Aged Nickel	Nero Black	Bianco White
.AR	.NA	.1	.5